

Technical Information

Tested to withstand force of (Joule)	5.600 J
Vehicle weight equivalent (kg)	3.000 kg
Vehicle equivalent speed (km/h)	7,0 km/h
Equivalent angle of impact	90°
Deflection zone	250 mm

Material Properties

Chemical Resistance	high- ISO/TR 10358
Temperature Range	-10° up to + 50°

Environment

Recyclability	100%
---------------	------

Other

Standard Warranty	5 years
-------------------	---------

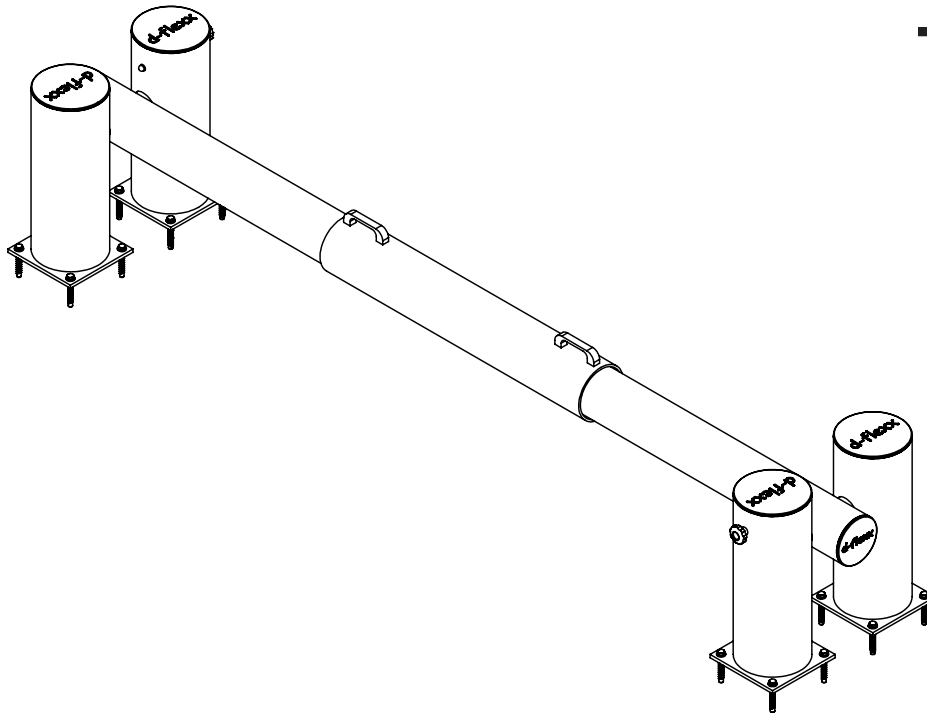

Testcenter Video

Art. No.	Description	Weight
DFNO-W2300	Dock Gate inside length 2300 mm	56,2 kg
DFNO-W2600	Dock Gate inside length 2600 mm	58,3 kg
DFNO-WI	Dock Gate individual inside length 2300 - 3300 mm	63,2 kg

Article description Dock Gate length inside 2300 mm
Item number DFNO-W2300
EAN 4250912395886
Customs tariff number 39269097



Height 516 mm
Width 585 mm
Length inside 2300 mm
Total length 2750 mm
Diameter
Deflection zone 250 mm

Net weight 56,2 kg
Material Polyethylene
Color Yellow (like RAL 1023 traffic yellow) / black
Indoor use Yes
Outdoor use Yes
Boreholes 16
Fixing The fixing material is included. The Fischer ULTRACUT FBS II is the perfect powerful concrete screw for top installation comfort.

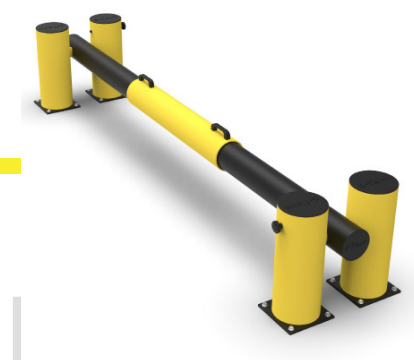

Material Properties

Chemical Resistance high- ISO/TR 10358
Temperature Range -10° up to + 50°

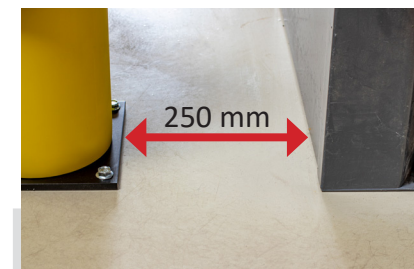

Environment

Recyclability 100%

Other

Standard Warranty 5 years

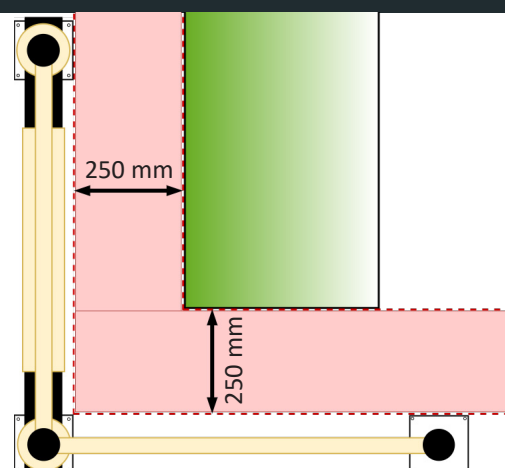
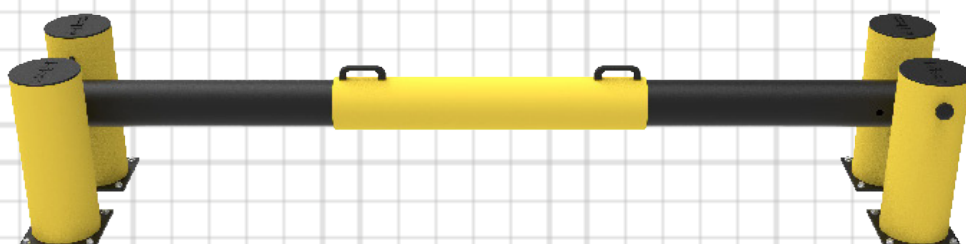

Article description Dock Gate length inside 2600 mm
Item number DFNO-W2600
EAN 4250912395978
Customs tariff number 39269097



Height 516 mm
Width 585 mm
Length 2600 mm
Total length 3050 mm
Diameter
Deflection zone 250 mm

Net weight 58,3 kg
Material Polyethylene
Color Yellow (like RAL 1023 traffic yellow) / black
Indoor use Yes
Outdoor use Yes
Boreholes 16
Fixing The fixing material is included. The Fischer ULTRACUT FBS II is the perfect powerful concrete screw for top installation comfort.

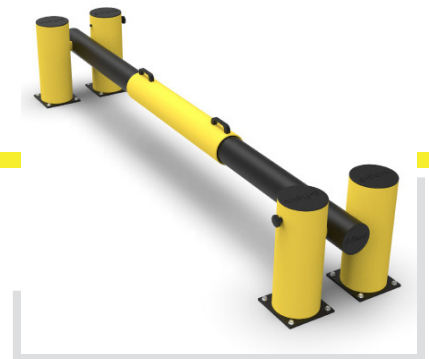

Material Properties

Chemical Resistance high- ISO/TR 10358
Temperature Range -10° up to + 50°

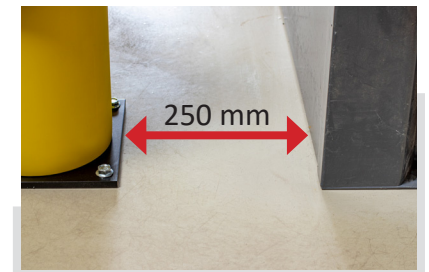

Environment

Recyclability 100%

Other

Standard Warranty 5 years

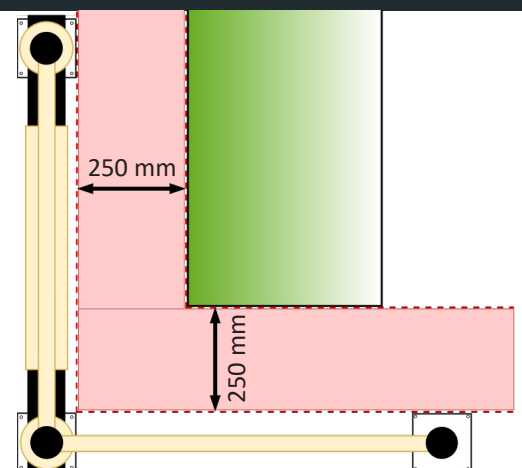
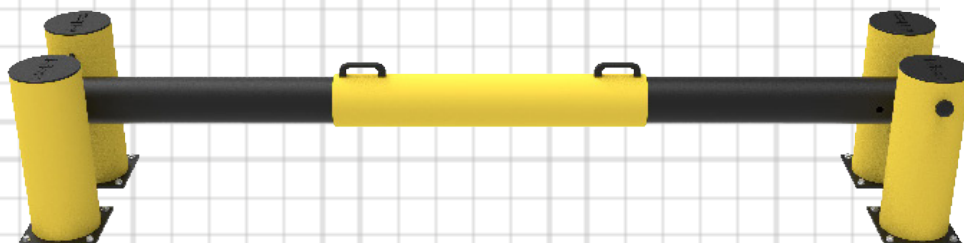

Article description	Dock Gate individual length inside 2300- 3300 mm
Item number	DFNO-WI
EAN	4250912395961
Customs tariff number	39269097



Height	516 mm
Width	585 mm
Length	2300- 3300 mm
Total length	2750- 3750 mm
Diameter	
Deflection zone	250 mm

Net weight	63,2 kg
Material	Polyethylene
Color	Yellow (like RAL 1023 traffic yellow) / black
Indoor use	Yes
Outdoor use	Yes
Boreholes	16
Fixing	The fixing material is included. The Fischer ULTRACUT FBS II is the perfect powerful concrete screw for top installation comfort.

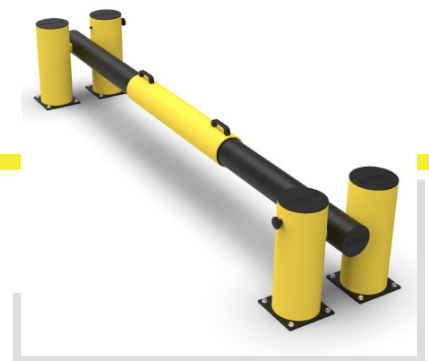

Material Properties

Chemical Resistance	high- ISO/TR 10358
Temperature Range	-10° up to + 50°

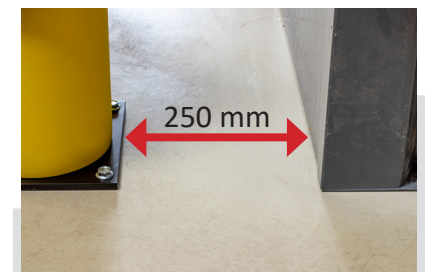

Environment

Recyclability 100%

Other

Standard Warranty 5 years

