



Safety Barrier - DELTA

DFFS-M-4E



DFFS-M-4M

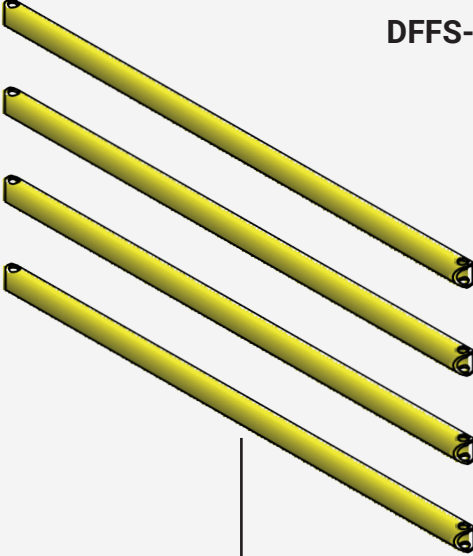

DFFS-M-4H1
DFFS-M-4HI



Table of contents

Art. No.	Description	Weight	Page
DFFS-M-4E	Delta 4 End post	8,5 kg	3
DFFS-M-4M	Delta 4 Middle post	8,7 kg	3
DFFS-M-4W90	Delta 4 Corner post 90°	8,7 kg	4
DFFS-M-4T	Delta 4 T-post	8,7 kg	4
DFFS-M-4K	Delta 4 Cross post	8,8 kg	5
DFFS-M-4W22.5	Delta 4 corner post 22.5°	8,7 kg	5
DFFS-M-4W45	Delta 4 corner post 45°	8,7 kg	6
DFFS-M-4W67.5	Delta 4 corner post 67.5°	8,7 kg	6
DFFS-M-4W292.5	Delta 4 corner post 292.5°	8,7 kg	7
DFFS-M-4W315	Delta 4 corner post 315°	8,7 kg	7
DFFS-M-4W337.5	Delta 4 corner post 337.5°	8,7 kg	8
DFFS-M-4H1	Delta 4 Beam Set, 1510 mm	6,0 kg	8
DFFS-M-4HI	Delta 4 Beam set with individual length	4,5 kg / m	9

Technical Information

Material properties

Operational temperature range	-40° up to + 50°
Ignition Temperature	350 - 360°C
Flash Point	350 - 360°C
Toxicity	Nontoxic
Chemical Resistance	high - ISO/TR 10358
Hygiene Seals	Non
Standard Warranty	5 years

Deflection Zone:

I 250 mm

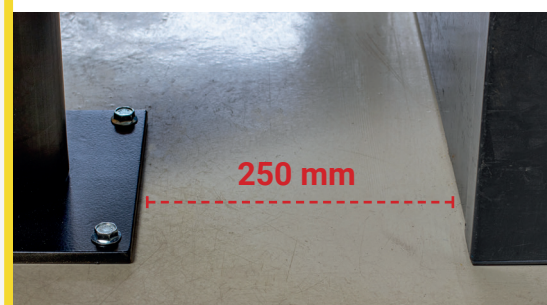

DFFS-M-4E

Article description	End post
Item number	DFFS-M-4E
EAN	4250912395329
Customs tariff number	39269097
Width (mm)	150
Height (mm)	1200
Depth/Length (mm)	150
Installation width (mm)	130
Width without foot plate (mm):	110
Depth without foot plate (mm):	110
Deflection zone (mm)	250
Tested to withstand force (Joule):	N/A
Net weight	8,7 kg
Material	Polyethylene
Color	Black
Area of application	Indoor and outdoor use
Fixing	Fixing Material included. 4 x concrete screw M10x70

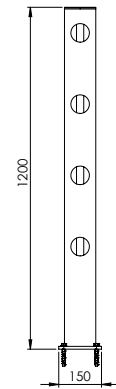

DFFS-M-4M

Article description	Middle post
Item number	DFFS-M-4M
EAN	4250912395343
Customs tariff number	39269097
Width (mm)	150
Height (mm)	1200
Depth/Length (mm)	150
Installation width (mm)	130
Width without foot plate (mm):	110
Depth without foot plate (mm):	110
Deflection zone (mm)	250
Tested to withstand force (Joule):	N/A
Net weight	8,7 kg
Material	Polyethylene
Color	Black
Area of application	Indoor and outdoor use
Fixing	Fixing Material included. 4 x concrete screw M10x70

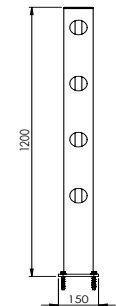

DFFS-M-4W90

Article description	Corner post 90°
Item number	DFFS-M-4W90
EAN	4250912395367
Customs tariff number	39269097
Width (mm)	150
Height (mm)	1200
Depth/Length (mm)	150
Installation width (mm)	130
Width without foot plate (mm):	110
Depth without foot plate (mm):	110
Deflection zone (mm)	250
Tested to withstand force (Joule):	N/A
Net weight	8,7 kg
Material	Polyethylene
Color	Black
Area of application	Indoor and outdoor use
Fixing	Fixing Material included. 4 x concrete screw M10x70

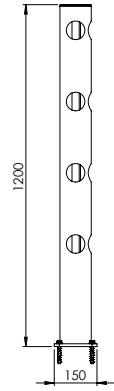

DFFS-M-4T

Article description	T-Post
Item number	DFFS-M-T
EAN	4250912395350
Customs tariff number	39269097
Width (mm)	150
Height (mm)	1200
Depth/Length (mm)	150
Installation width (mm)	130
Width without foot plate (mm):	110
Depth without foot plate (mm):	110
Deflection zone (mm)	250
Tested to withstand force (Joule):	N/A
Net weight	8,7 kg
Material	Polyethylene
Color	Black
Area of application	Indoor and outdoor use
Fixing	Fixing Material included. 4 x concrete screw M10x70

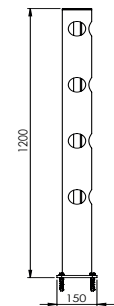

DFFS-M-4K

Article description	Cross post
Item number	DFFS-M-4K
EAN	4250912395336
Customs tariff number	39269097
Width (mm)	150
Height (mm)	1200
Depth/Length (mm)	150
Installation width (mm)	130
Width without foot plate (mm):	110
Depth without foot plate (mm):	110
Deflection zone (mm)	250
Tested to withstand force (Joule):	N/A
Net weight	8,7 kg
Material	Polyethylene
Color	Black
Area of application	Indoor and outdoor use
Fixing	Fixing Material included. 4 x concrete screw M10x70

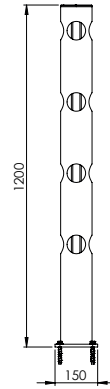

DFFS-M-4W22.5

Article description	Corner post 22.5°
Item number	DFFS-M-4W22.5
EAN	4250912397583
Customs tariff number	39269097
Width (mm)	150
Height (mm)	1200
Depth/Length (mm)	150
Installation width (mm)	130
Width without foot plate (mm):	110
Depth without foot plate (mm):	110
Deflection zone (mm)	250
Tested to withstand force (Joule):	N/A
Net weight	8,7 kg
Material	Polyethylene
Color	Black
Area of application	Indoor and outdoor use
Fixing	Fixing Material included. 4 x concrete screw M10x70

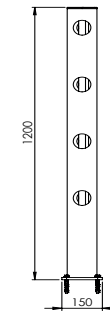

DFFS-M-4W45

Article description	Corner post 45°
Item number	DFFS-M-4W45
EAN	4250912397590
Customs tariff number	39269097
Width (mm)	150
Height (mm)	1200
Depth/Length (mm)	150
Installation width (mm)	130
Width without foot plate (mm):	110
Depth without foot plate (mm):	110
Deflection zone (mm)	250
Tested to withstand force (Joule):	N/A
Net weight	8,7 kg
Material	Polyethylene
Color	Black
Area of application	Indoor and outdoor use
Fixing	Fixing Material included. 4 x concrete screw M10x70

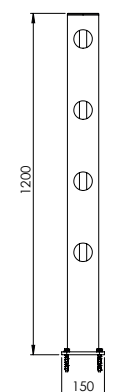

DFFS-M-4W67.5

Article description	Corner post 67.5°
Item number	DFFS-M-4W67.5
EAN	4250912397606
Customs tariff number	39269097
Width (mm)	150
Height (mm)	1200
Depth/Length (mm)	150
Installation width (mm)	130
Width without foot plate (mm):	110
Depth without foot plate (mm):	110
Deflection zone (mm)	250
Tested to withstand force (Joule):	N/A
Net weight	8,7 kg
Material	Polyethylene
Color	Black
Area of application	Indoor and outdoor use
Fixing	Fixing Material included. 4 x concrete screw M10x70

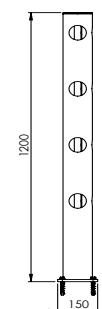

DFFS-M-4W292.5

Article description	Corner post 292.5°
Item number	DFFS-M-4W292.5
EAN	4250912397613
Customs tariff number	39269097
Width (mm)	150
Height (mm)	1200
Depth/Length (mm)	150
Installation width (mm)	130
Width without foot plate (mm):	110
Depth without foot plate (mm):	110
Deflection zone (mm)	250
Tested to withstand force (Joule):	N/A
Net weight	8,7 kg
Material	Polyethylene
Color	Black
Area of application	Indoor and outdoor use
Fixing	Fixing Material included. 4 x concrete screw M10x70

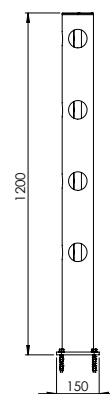

DFFS-M-4W315

Article description	Delta Corner post 315°
Item number	DFFS-M-4W315
EAN	4250912397620
Customs tariff number	39269097
Width (mm)	150
Height (mm)	1200
Depth/Length (mm)	150
Installation width (mm)	130
Width without foot plate (mm):	110
Depth without foot plate (mm):	110
Deflection zone (mm)	250
Tested to withstand force (Joule):	N/A
Net weight	8,7 kg
Material	Polyethylene
Color	Black
Area of application	Indoor and outdoor use
Fixing	Fixing Material included. 4 x concrete screw M10x70

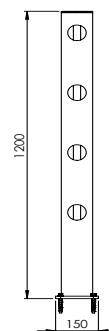

DFFS-M-4W337.5

Article description	Delta Corner post 337,5°
Item number	DFFS-M-4W337.5
EAN	4250912397637
Customs tariff number	39269097
Width (mm)	150
Height (mm)	1200
Depth/Length (mm)	150
Installation width (mm)	130
Width without foot plate (mm):	110
Depth without foot plate (mm):	110
Deflection zone (mm)	250
Tested to withstand force (Joule):	N/A
Net weight	8,7 kg
Material	Polyethylene
Color	Black
Area of application	Indoor and outdoor use
Fixing	Fixing Material included. 4 x concrete screw M10x70

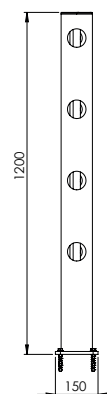

DFFS-M-4H1

Article description	Beam set
Item number	DFFS-M-4H1
EAN	4250912312319
Customs tariff number	39269097
Width (mm)	1510
Height (mm)	N/A
Depth/Length (mm)	N/A
Installation width (mm)	1420
Width without foot plate (mm):	N/A
Depth without foot plate (mm):	N/A
Deflection zone (mm)	see post
Tested to withstand force (Joule):	N/A
Net weight	1,548 kg
Material	Polyethylene
Color	Yellow RAL 1018
Area of application	Indoor and outdoor use
Fixing	Screw together

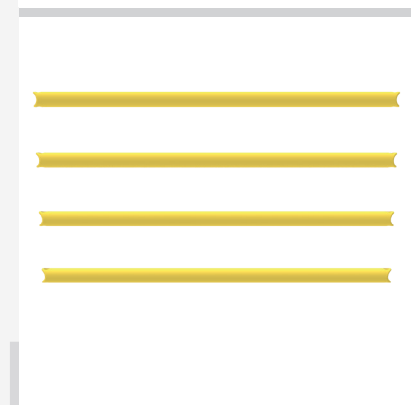
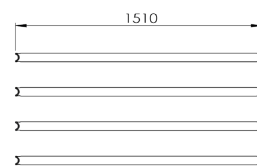

DFFS-M-4HI



Article description	Beam set with individual length
Item number	DFFS-M-4HI
EAN	4250912312326
Customs tariff number	39269097
Width (mm)	350-1509
Height (mm)	N/A
Depth/Length (mm)	N/A
Installation width (mm)	260-1419
Width without foot plate (mm):	N/A
Depth without foot plate (mm):	N/A
Deflection zone (mm)	see post
Tested to withstand force (Joule):	N/A
Net weight	4,5 kg / m
Material	Polyethylene
Color	Yellow RAL 1018
Area of application	Indoor and outdoor use
Fixing	Screw together

